

Owner's Manual with Installation Instructions

Banks Ram-Air® Intake System

2015 Chevrolet 6.6L (LML) Duramax Turbo-Diesel Pickups

THIS MANUAL IS FOR USE WITH KIT 42248 & 42248-D

Gale Banks Engineering
546 Duggan Avenue • Azusa, CA 91702
(626) 969-9600 • Fax (626) 334-1743

Product Information & Sales: (888) 635-4565
Customer Support: (888) 839-5600
Installation Support: (888) 839-2700

bankspower.com



General Installation Practices

Dear Customer,

If you have any questions concerning the installation of your Banks Ram-Air System, please call our Technical Service Hotline at (888) 839-2700 between 7:00 am and 4:00 pm (PT). If you have any questions relating to shipping or billing, please contact our Customer Service Department at (888) 839-5600.

Thank you.

1. For ease of installation of your Banks Ram-air intake system, familiarize yourself with the procedure by reading the entire manual before starting work.
2. The exploded view of the Ram-Air assembly (pages 4-5) provides only general guidance. Refer to each step and section diagram in this manual for proper instruction.
3. Throughout this manual, the left side of the vehicle refers to the driver's side, and the right-side to the passenger's side.
4. Disconnect the ground cable from the battery before beginning work. If there are two batteries, disconnect both.
5. Route and tie wires and hoses a minimum of 6 inches away from exhaust heat, moving parts and sharp edges. Clearance of 8 inches or more is recommended where possible.

6. During installation, keep the work area clean. If foreign debris is transferred to any Banks system component, clean it thoroughly before installing.

7. When raising the vehicle, support it on properly weight-rated safety stands, ramps or a commercial hoist. Follow the manufacturer's safety precautions. Take care to balance the vehicle to prevent it from slipping or falling. When using ramps, be sure the front wheels are centered squarely on the topsides; put the transmission in park; set the parking brake; and place blocks behind the rear wheels.

⚠ CAUTION: Do not use floor jacks to support the vehicle while working under it. Do not raise the vehicle onto concrete blocks, masonry or any other item not intended specifically for this use.

NOTICE: The Banks Oiled Ram-Air Filter comes pre-oiled and no oiling is necessary for initial installation. Service the filter as specified in the Ram-Air Filter Cleaning Instructions Section of this manual.

Tools Required:

- 1/4" or 3/8" drive ratchets with metric sockets
- Standard and Phillips head screwdrivers
- Clean shop towels or rags
- 5/16" nut driver

Table of Contents

Section 1 **4**
General Assembly

Section 2 **6**
Ram-Air Installation

Section 3
Oiled Air Filter Cleaning Instructions. . . **11**
Dry Air Filter Cleaning Instructions . . . **12**

Section 1

General Assembly

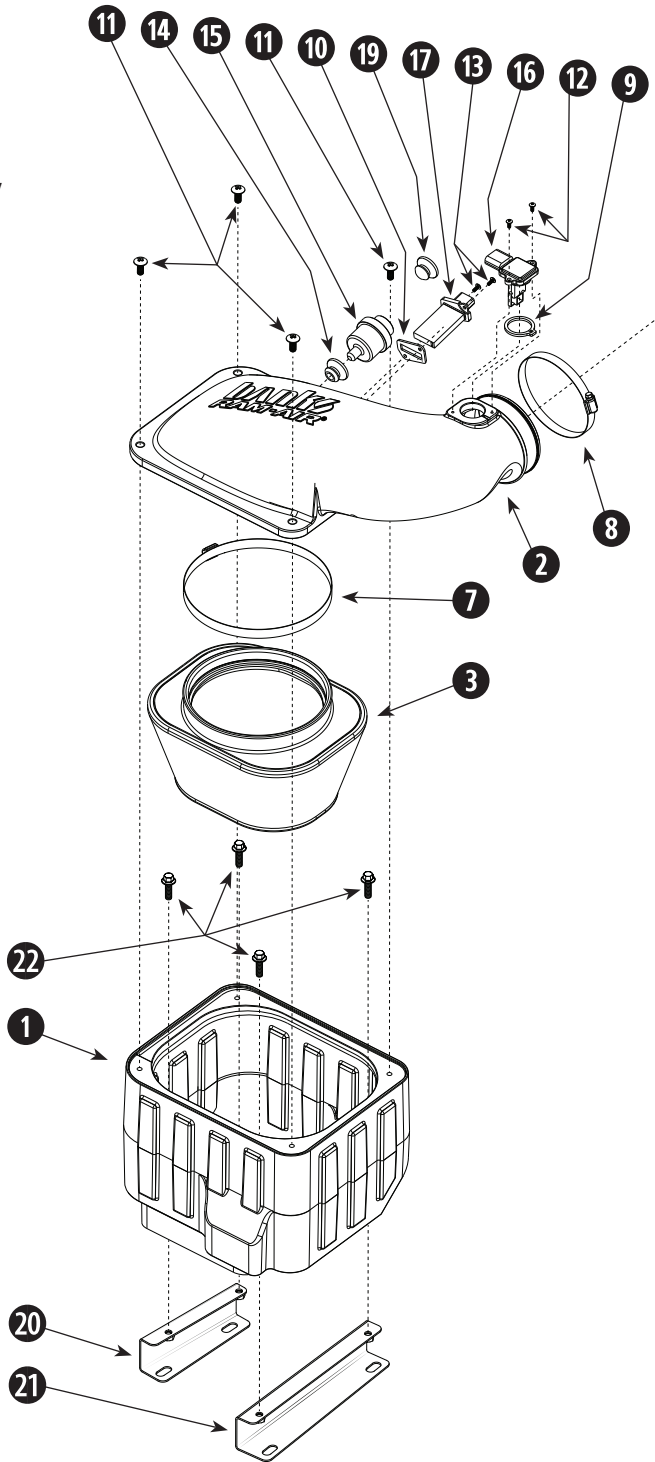

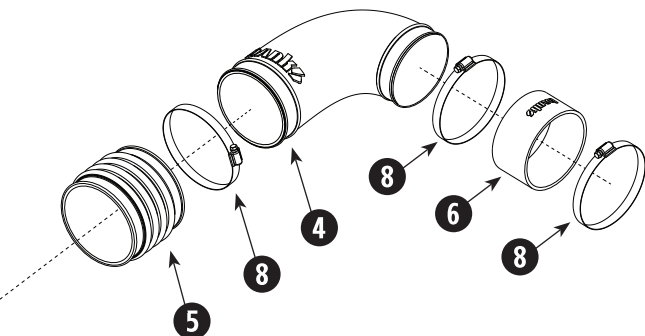

Item	Description	Part#	Qty
1	FILTER HOUSING, Ram-Air	42221	1
2	FILTER HOUSING COVER, Ram-Air	42224	1
3	AIR FILTER ELEMENT	42138/42138-D	1
4	INTAKE TUBE, Ram-Air	42223	1
5	HOSE, BELLOWS	94300	1
6	HOSE, COMPRESSOR INLET	94301	1
7	HOSE CLAMP, #128	92928	1
8	HOSE CLAMP, #72 w/LINER	92872	4
9	GASKET, MAF	93072	1
10	GASKET, MAF	93067	1
11	SCREW, TRUSS HEAD, PHILLIPS, $\frac{5}{16}$ -18 X $\frac{3}{4}$	91226	4
12	SCREW, TRUSS HEAD, PHILLIPS, 6-32 X $\frac{5}{8}$	91839	2
13	SCREW, TRUSS HEAD, PHILLIPS, 6-32 X $\frac{1}{2}$	91719	2
14	STOCK GROMMET, FILTER MINDER	*	
15	STOCK FILTER MINDER	*	
16	STOCK MAF SENSOR	*	
17	STOCK INTAKE SENSOR	*	
18	TORX TOOL, T20H (not shown)	92987	1
19	PLUG, FILTER MINDER	92440	1
20	BRACKET, RIGHT, HOUSING	42252	1
21	BRACKET, LEFT, HOUSING	42251	1
22	BOLT, FLANGE HEAD, M6-1mm x 20mm	91756	4

Section 2

RAM-AIR INSTALLATION

You are about to install the Banks Ram-Air Intake System. Read and follow all steps before working on the vehicle. Some components from the stock air intake system will remain in service. Take care when removing stock air intake components to not damage them.

Use the Bill of Materials Chart and the General Assembly Drawing to reference component nomenclature and location. Use caution when working in the engine compartment. Make sure the engine has been OFF for several hours and cool.

1. Loosen the hose clamp from the stock intake tube on the compressor inlet.
2. Loosen the stock hose clamp on the intake air tube to separate it from the stock air box cover. See **Figure 1**.
3. Separate the stock intake tube

connected to the compressor inlet tube. Remove the stock intake tube from the engine and set aside.

4. Disconnect the Mass Air Flow (MAF) and intake sensor connector.

NOTE: Be careful not to damage the connector or the MAF sensor during this process.

5. Remove stock air box by lifting the air box up and out. The bottom of the stock air box is held in place by rubber grommets. There may be some resistance when removing the stock air box.

6. Next, remove the stock air box tray bolts accessible from the top of the engine compartment as shown. Then remove the stock air box tray. See **Figure 2**.

7. Install brackets (PN#s 42251 & 42252) with previously removed bolts. See **Figure 3**.

Figure 1- Separate Intake Air Tube from Stock Air Box Cover

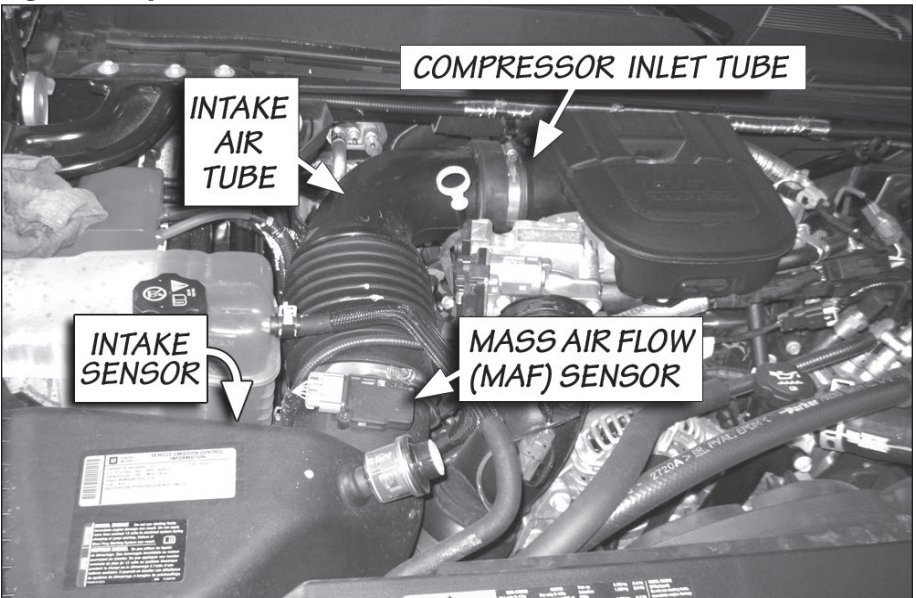

Figure 2-Remove Stock Air Box Bolts

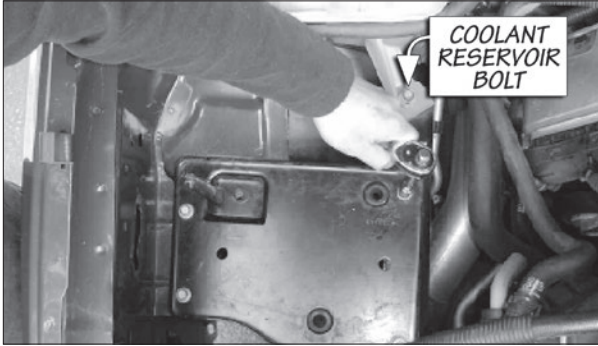
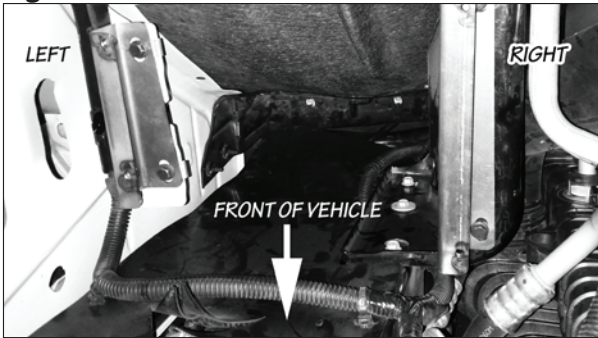

Figure 3



8. Locate your Banks Ram-Air filter housing from your kit. Align the Banks Ram-Air filter housing to fit parallel to fender edge. Install using the supplied (4) M6 bolts (PN# 91756) to secure the Banks Ram-Air filter housing.

*NOTE: The cutout on Banks Ram-Air filter housing must face passenger side fender. See **Figure 4**.*

*NOTE: In case of interference between Banks housing and stock coolant reservoir, loosen coolant reservoir bolt (See **Figure 2**), slide coolant reservoir rearward and retighten bolt.*

9. Locate your Banks Torx tool, T20H in your Banks Ram-Air kit. Use the Torx tool bit to remove the four (4) screws securing the MAF sensor and intake sensor to the stock air box cover.

Leave the factory gasket on the MAF sensor in place.

NOTE: Be careful when removing the MAF Sensor. When removing the MAF sensor, grasp its body and pull up and out. Do not twist or bend when removing.

10a. Locate the supplied Banks MAF sensor gasket and install Banks gasket on the MAF sensor. Make sure the sensor is properly installed. Install the MAF sensor (with the additional Banks gasket) on the Ram-Air Cover sensor boss. See **Figure 5a**.

10b. Remove stock intake sensor gasket. Locate the Banks intake sensor gasket supplied in your kit. See **Figure 5b**.

11. Locate your Banks Ram-Air filter housing cover in your kit. Install the stock MAF sensor and intake sensor (with the additional Banks gaskets) to MAF sensor mounting bosses as shown. Tighten the screws (included) to 3 in/lbs.

NOTE: Ensure correct alignment, otherwise screw holes will not align with screw holes in the Banks Ram-Air filter housing cover.

CAUTION: DO NOT OVER TIGHTEN SCREWS

Figure 4:
Position
Cut-out
to Face
Passenger
Side
Fender

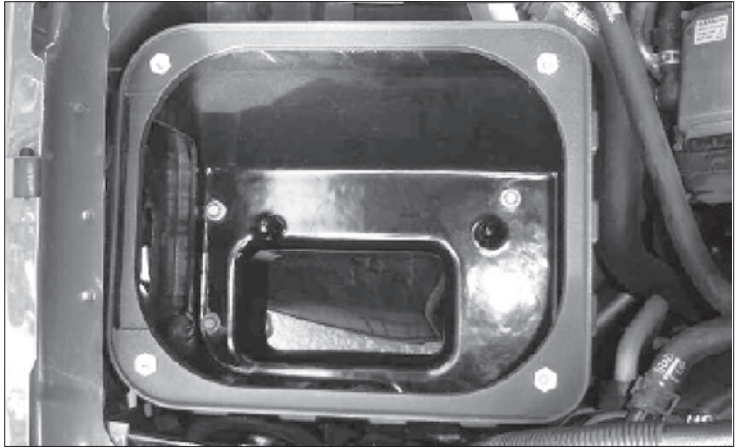

Figure 5a:
Install Banks
MAF Gasket

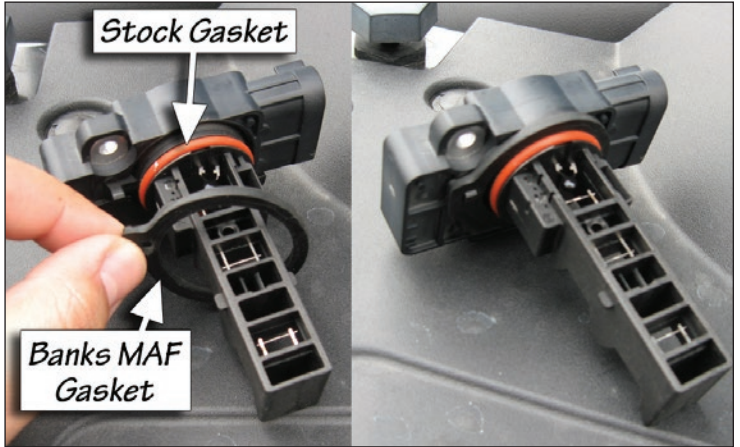
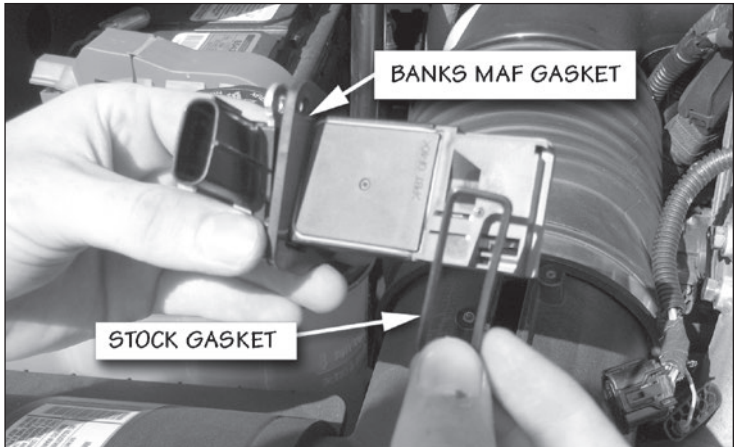

Figure 5b:



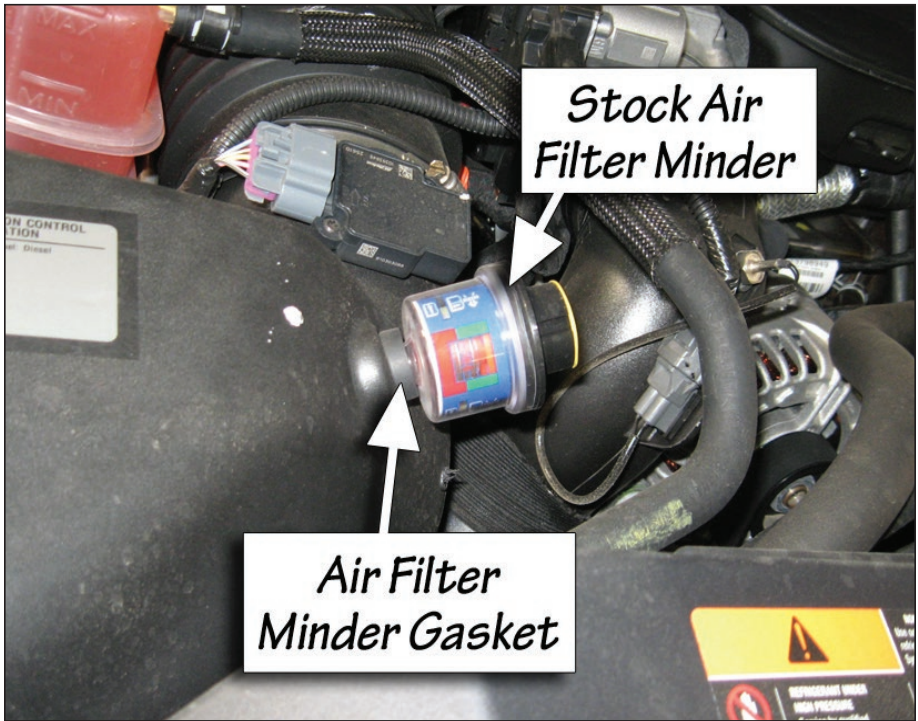

Figure 6- Remove Stock Air Filter Minder & Air Filter Minder Gasket

12. From the stock air box, remove the stock air filter Minder. Make sure to remove the stock air filter Minder's rubber grommet as well. See **Figure 6**.

13. Install the air filter Minder's rubber grommet into the Banks Ram-Air filter housing cover. Once the rubber grommet is installed flush into the Banks Ram-Air cover, then the filter Minder can be inserted into the rubber grommet. Make sure the air filter Minder is installed flush to rubber grommet.

14. Locate the Banks Ram-Air filter element and the Banks air filter hose clamp. Loosely fit the filter clamp to the air filter element.

*NOTE: See **Figure 7** to reference the correct alignment locator groove to the Banks Ram-Air filter.*

15. After verifying the alignment between the Banks Ram-Air filter and the Banks Ram-Air cover, press fit the two pieces together until an audible snap is heard. This process will ensure that a correct seal has been established.

16. Tighten the Banks Ram-Air filter hose clamp to the Banks Ram-Air filter cover.

17. Place the Banks Ram-Air filter cover onto the Banks Ram-Air housing. Align and loosely fit the cover onto the housing.

18. Install, but do not tighten, the Banks bellows hose and hose clamp onto the Banks Ram-Air housing cover.

19. Locate the Banks compressor inlet hose, tube, and hose clamps from your Banks Ram-Air kit. Loosely assemble the Banks compressor inlet hose to the Banks intake tube with the supplied hose clamps. Attach the compressor inlet hose to the compressor inlet. Leave the hose clamps loose.

20. Install the Banks Ram-Air intake tube into the Banks bellows. Tighten all the hose clamps to secure the Banks intake tube. See **Figure 8**.

CAUTION: Ensure Intake tube is not touching any engine components.

21. Fasten the Banks air filter cover to the Banks air filter housing using the Banks cover screws and tighten.

22. Re-attach the sensor connectors to the sensors in the Banks Ram-Air® cover.

23. Re-connect battery grounds. You have successfully completed the installation of the Banks Ram-Air Intake system. Make sure to check all hose clamps for tightness and connectors for a sure fit. Make sure that the intake tube is not touching any engine components.

Figure 7- Align Locator Groove to the Banks Ram-Air Filter

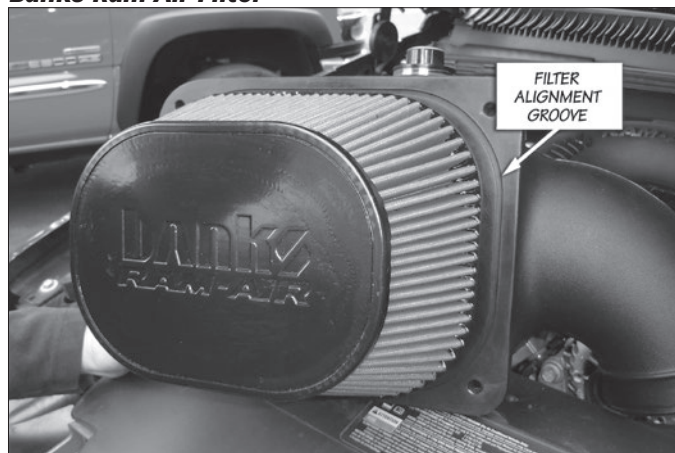
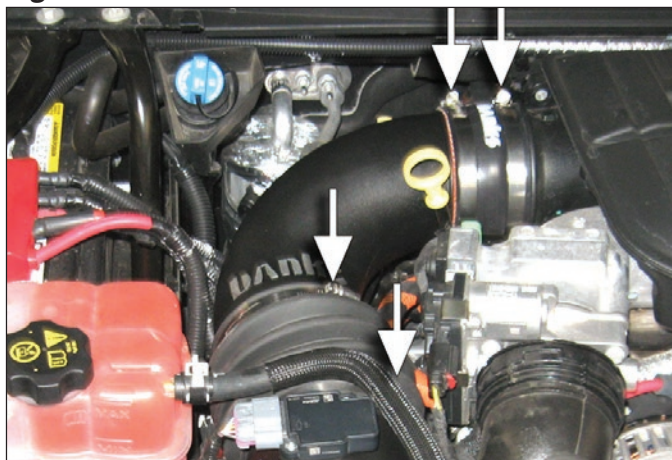

Figure 8- Secure Banks Intake Tube



For vehicles without a factory filter minder insert rubber plug (P/N 92440). See item #19 on illustration on page 4.

Section 3

AIR FILTER CLEANING INSTRUCTIONS

OILED AIR FILTER ONLY

NOTICE: The Banks Ram-Air Oiled Air Filter comes pre-oiled and no oiling is necessary for initial installation. Use Banks Ram-Air Filter Cleaning System (part#90094), available from Gale Banks Engineering to service the Air Filter. Follow the instructions included with the cleaning system to clean and re-oil your Bank Ram-Air Oiled Air Filter.

1. PRE-CLEANING

Tap the element to dislodge any large embedded dirt, then gently brush with a soft bristle brush. *NOTE: If complete cleaning is not practical at this time, reoil the element and reinstall in your vehicle.*

2. SPRAY-ON CLEANING

Spray air-filter cleaner liberally onto the entire element and let soak for 10 minutes.

3. PAN CLEANING

Large air-filter elements can be rolled or soaked in a shallow pan of air-filter cleaner. Remove immediately and let soak for approximately 10 minutes.

NOTICE: NEVER use gasoline, steam, caustic solutions, strong detergents, high-pressure nozzles, or cleaning solvents to clean the filter element. All of these can cause harm to the filter media as well as SHRINK and HARDEN the rubber end caps.

4. RINSING

Rinse off the element with low-pressure water. Tap water is okay. Always flush from the clean side to dirty side. This removes the dirt

and does not drive it into the filter.

5. DRYING

Always dry naturally. After rinsing, shake off all excess water and let the element dry naturally.

6. AEROSOL OILING

After cleaning air filter always reoil before using. Spray air filter oil down into each pleat with one pass per pleat. Wait 10 minutes and re-oil any white spots still showing.

7. OILING HINTS

Never use a Banks Ram-Air filter without oil (the filter will not stop the dirt without the oil). Use only air filter oil. Air-filter oil is a compound of mineral and animal oil blended with special polymers to form a very efficient tack barrier. Red dye is added to show just where you have applied the oil. Eventually the red color will fade but the oil will remain and filter the air. NEVER USE Automatic Transmission Fluid. NEVER USE Motor Oil. NEVER USE Diesel Fuel. NEVER USE WD40, LPS, or other light-weight oils.

8. REINSTALL

Reinstall your Banks Ram-Air filter element with proper care. Make sure the element seats properly in the filter case. Install the cover making sure it's in the right position. Tighten all the nuts, bolts, screws or clips to factory specifications.

9. DO NOT DISCARD

Affix the "Do Not Discard" sticker to the filter case (included with every Banks replacement element). Make sure you put the sticker in a highly visible place to alert your mechanic not to discard.

10. PERFORMANCE HINTS

Service every 50-100,000 miles on

street-driven applications. Service more often in offroad or heavy-dust conditions. If an air-filter restriction gauge is installed, then change the element when the air-filter restriction reaches 18"–H.O.

⚠ CAUTION: **Extremely fine dust from agriculture or offroad use will pull the oil from the element. Frequent reoiling of the element's clean side might be required. Completely service when practicable. For extra protection use an air-filter sealing grease on rubber ends of the element. Service only with air-filter cleaner and air-filter oil.**

DRY FILTER CLEANING

Clean every 50-100,000 miles on street-driven applications. Clean more often in offroad or heavy-dust conditions. If an air-filter restriction gauge is installed, then change the element when the air-filter restriction reaches 18"–H.O.

1. PRE-CLEANING

Carefully tap the air filter element to dislodge any large embedded dirt or debris.

2. CLEANING

Spray an appropriate DRY AIR-FILTER CLEANER SOLUTION liberally onto both sides of the entire filter element with the majority applied to the dirty side. Soak for 10 minutes. Do not allow the DRY AIR-FILTER CLEANER SOLUTION to dry on the air filter.

NOTICE: **NEVER use gasoline, steam, caustic solutions, strong detergents, high-pressure nozzles, or cleaning solvents to clean the filter element.** All of these can cause harm to the filter media as well as SHRINK and HARDEN the rubber end caps.

3. RINSING

Rinse the filter element with cool or warm (not hot) water from the clean side out in order to flush the dirt out of the filter. It may be necessary to use your fingers on the hose to apply light water pressure. Repeat steps 2 and 3, until the water flowing through the media is completely clear of any dirt and debris.

5. DRYING

After rinsing, gently shake off excessive water and allow to dry naturally. Re-install the filter onto the intake system, airbox or custom assembly once it is dry or just slightly damp. Follow all original installation instructions.

6. REINSTALL

Reinstall your Banks Ram-Air filter element with proper care. Make sure the element seats properly in the filter case. Install the cover making sure it's in the right position. Tighten all the nuts, bolts, screws or clips to factory specifications.

7. DO NOT DISCARD

Affix the "Do Not Discard" sticker to the filter case (included with every Banks replacement element). Make sure you put the sticker in a highly visible place to alert your mechanic not to discard.

8. PERFORMANCE HINTS

Service every 50-100,000 miles on street-driven applications. Service more often in offroad or heavy-dust conditions. If an air-filter restriction gauge is installed, then change the element when the air-filter restriction reaches 18"–H.O.

Gale Banks Engineering
546 Duggan Avenue • Azusa, CA 91702
(626) 969-9600 • Fax (626) 334-1743

Product Information & Sales: (888) 635-4565
Customer Support: (888) 839-5600
Installation Support: (888) 839-2700

bankspower.com