

# PULSAR

User Manual

Ram Hemi 2015-2022

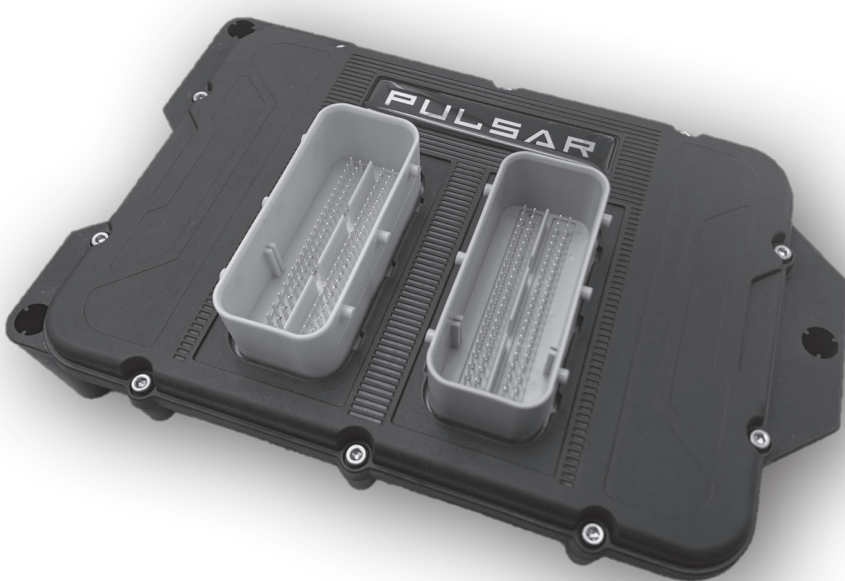

***Ram Hemi***

# Table of Contents

---

<b>3</b>	<b>Read Me</b>		
3	Safety Warning & Caution	<b>33</b>	<b>6.4L Axle Ratio</b>
4	Safety Guidelines	33	2015-2022 Axle Ratio
<b>5</b>	<b>Installation 5.7L Hemi</b>	35	Read & Clear DTCs
5	Materials	<b>36</b>	<b>Update Software</b>
5	Required Tools	36	Downloading Update Agent
6	ECM Removal	37	Product Updates
7	Pulsar Installation	<b>38</b>	<b>Frequently Asked Questions</b>
<b>9</b>	<b>5.7L Controls</b>		
9	Steering Wheels Controls		
9	Accelerator Pedal Controls		
<b>10</b>	<b>5.7L Power Levels</b>		
10	Levels Explained		
10	In-Dash Level Indicators		
11	Changing Power Levels (2015-2018)		
12	Changing Power Levels (2019-2022)		
<b>13</b>	<b>5.7L Tire Size</b>		
13	Tire Size Explained		
13	2015-2018 Tire Size		
15	2019-2022 Tire Size		
<b>16</b>	<b>5.7L Axle Ratio</b>		
16	2015-2018 Axle Ratio		
18	2019-2022 Axle Ratio		
19	Read & Clear DTCs		
<b>20</b>	<b>Installation 2015-2018 6.4L Hemi</b>		
20	Materials		
20	Required Tools		
21	ECM Removal		
22	Pulsar Installation		
<b>24</b>	<b>Installation 2019-2022 6.4L Hemi</b>		
24	Materials		
24	Required Tools		
25	ECM Removal		
26	Pulsar Installation		
<b>28</b>	<b>6.4L Controls</b>		
28	Steering Wheels Controls		
28	Accelerator Pedal Controls		
<b>29</b>	<b>6.4L Power Levels</b>		
29	Levels Explained		
29	In-Dash Level Indicators		
30	Changing Power Levels (2015-2022)		
<b>31</b>	<b>6.4L Tire Size</b>		
31	Tire Size Explained		
31	2015-2022 Tire Size		

# Read Me

## Safety Warning & Caution

Throughout this User Manual you will see important messages regarding your safety or the protection of your vehicle. These messages are designated by the words WARNING, CAUTION, or NOTICE.

### WARNING

A *WARNING* indicates a hazardous situation which, if not avoided, will result in death or serious injury.

### CAUTION

A *CAUTION* indicates a hazardous situation which, if not avoided, could result in minor or moderate injury.

### **NOTICE**

A *NOTICE* indicates a condition that could cause damage to the product or your vehicle.

### **NOTE**

A *NOTE* is a step or reminder that is important to remember when installing or using the product.

The product you have purchased is a high-performance product. As such, it does present some risks of which you should be fully aware. Do not use this product until you have carefully read the following safety information and the Owner Agreement.

** WARNING:** *Prior to use, read the User Manual. Misuse of the device could result in traffic accidents, death or serious injury, and/or damage to your vehicle. HOLLEY IS NOT RESPONSIBLE FOR AND SHALL HAVE NO LIABILITY TO YOU FOR ANY CLAIMS ARISING OUT OF OR RELATING TO ANY MISAPPLICATION OF THE DEVICE, CUSTOM TUNES, IMPROPER USE OF CALIBRATIONS, MALFUNCTION OR LACK OF LEGAL COMPLIANCE FOR CUSTOM PROGRAMS CREATED BY THIRD PARTIES.*

---

# Safety Guidelines

---



**Before using device, read and understand the user manual, including these additional safety instructions. Failure to do so could result in DEATH or SERIOUS INJURY.**

- Do not exceed legal speed limits on public roadways. Violating traffic laws is dangerous and could result in injury or vehicle damage or both.
- Use any enhanced speed capabilities of this product only in closed circuit, legally sanctioned racing environments expressly for this purpose. Violating traffic laws is dangerous and could result in injury or vehicle damage or both.
- Do not operate the device while driving. Distracted driving could result in traffic accidents, death or serious injury, and/or damage to your vehicle.
- Always perform all adjustments or changes while stopped. Changing a setting while driving can interfere with your attention to roadway conditions and could result in injury or vehicle damage or both.
- Do not stack products. “Stacking” performance-enhancing devices or other improper installation can cause power train failure on the road. Other products may have features incompatible with your device. Follow all installation and operating instructions.
- Some modifications may affect other parts of your vehicle. For example, if you remove/adjust the speed limiter in your vehicle, be sure your tires and other components are rated for the increased speeds they will have to withstand. Not doing so can lead to loss of vehicle control. Modify the speed limiter only for use in closed circuit, legally sanctioned racing environments, not for use on public roadways.

***NOTE: The stickers included in some products apply to products that have recieved CARB exemption for emissions compliance.***

This product may meet the emissions compliance requirements of the California Air Resources Board (CARB) and Federal Environmental Protection Agency (EPA). If so, it is legal for sale and use on pollution-controlled vehicles operated on public streets and highways. The device must be installed and operated according to the instructions provided in this user's manual. Included with these compliant products is a sticker (similar to the one pictured above) for you to install in your vehicle. Please clean a flat visible surface under the hood and affix the enclosed CARB EO sticker for SMOG purposes. An example of the need for this sticker would be something to show an emissions technician when taking your vehicle in for an emissions check to let him/her know the product is CARB emissions compliant.

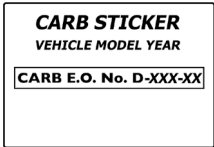

# Installation 5.7L Hemi

---

## Materials

---

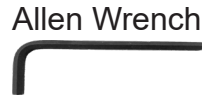
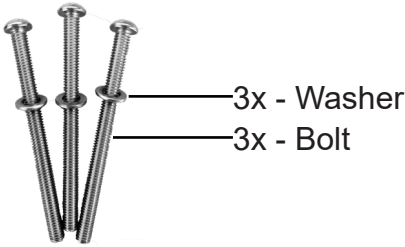

---

## Required Tools

---

Flat Head Screw Driver

1/4 Drive Ratchet

10mm Socket

8mm Socket

Allen Wrench (provided)

*Note: It may be easier to use a 4mm Allen*

*Socket instead of provided tool.*

# ECM Removal

**STEP 1** - Disconnect and remove the negative battery terminal.

**STEP 2** - Locate the vehicle's ECM.

**2015-2018**

Passenger Side Firewall

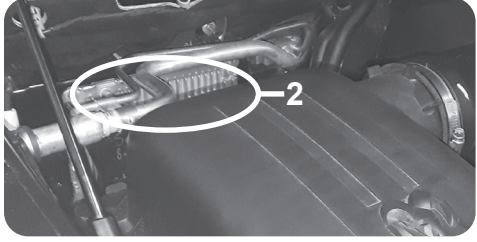

*TIP: Remove the air filter housing for easier access.*

Cut the (2) zip ties that fasten each connector harness to the metal bracket. (2015-18 Only)

**2019-2022**

Driver Side Battery

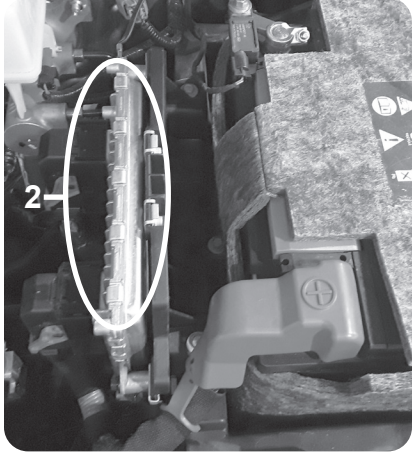

**STEP 3** - Use a flat head screw driver to press the lever lock towards the ECM. Gently lift up on the lever until you feel the lever release.

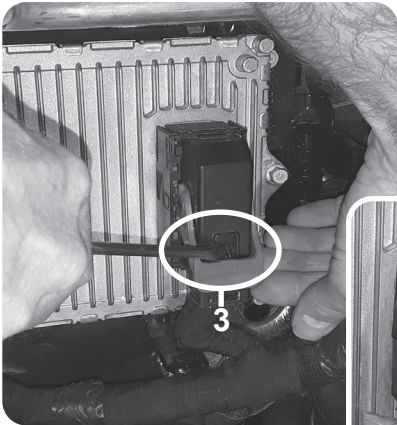

**STEP 4** - Once the lever is released, lift it upward until it stops. Disconnect the connector from the ECM.



**NOTE:** Follow steps 3 & 4 to remove both connectors.

## Pulsar Installation

**STEP 5** - Use a 10mm (8mm for 2019-22) socket to loosen the 3 screws that fasten the ECM to the bracket. (For 2019-22 only, remove the grounding cable lug and set aside.)

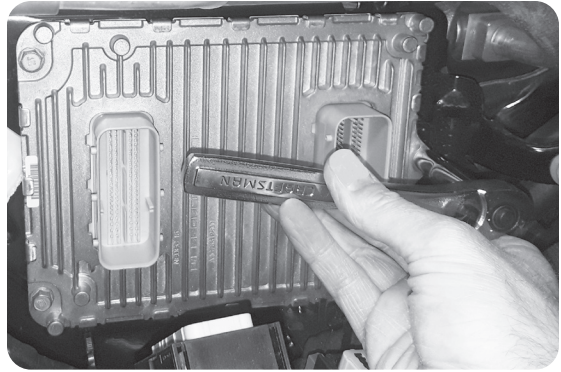

*TIP: Hold the ECM with your other hand to prevent it from falling after the last screw is removed.*

*TIP: Place the stock screws into a zip lock bag and store it in the glove box.*

**STEP 6** - Orient Pulsar and the ECM as shown. The three holes (A, B, & C) will be used to fasten the assembly to the bracket.

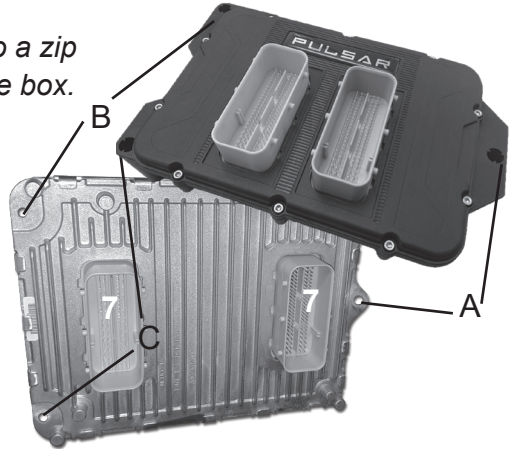

**STEP 7** - Align and insert the Pulsar's bottom side connectors with the ECM connectors.

**STEP 8** - While on a flat surface, apply enough pressure to fully seat the connectors. The top of the ECM connectors should sit flush with the Pulsar enclosure.

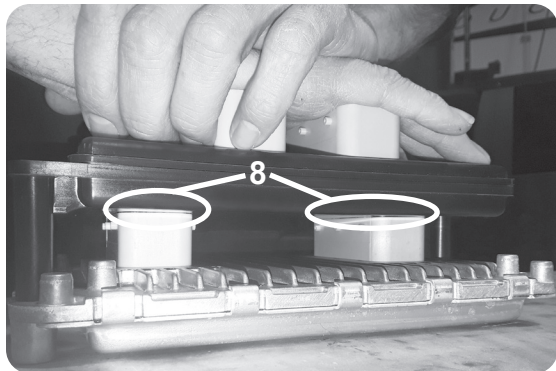

---

## Pulsar Installation Cont'd

---

**STEP 9** - Align the Pulsar assembly holes with the threaded holes on the vehicle mounting bracket. Insert the provided bolts (w/ washers) and fasten the assembly to the bracket using the provided Allen Wrench. Tighten until snug.

*(For 2019-22 only, install the ground cable lug (removed in step 5) between the supplied washer and plastic housing.)*

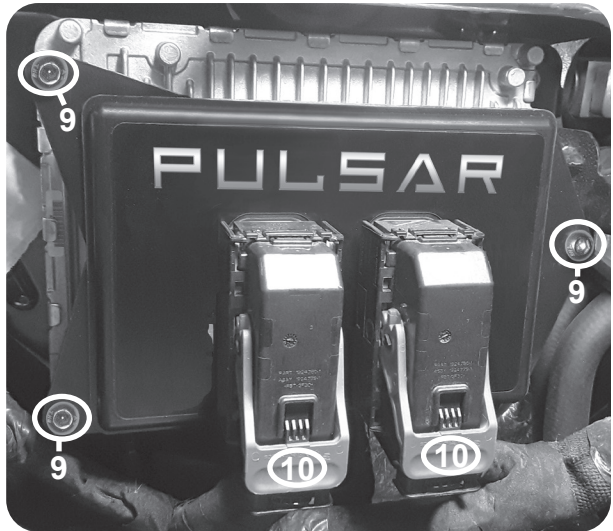

**STEP 10** - Gently insert the truck harness connectors into the Pulsar connectors. Push the lever down until it locks into place.

**STEP 11** - Re-install the air intake. *(2015-18 Only)*

**STEP 12** - Reconnect the negative battery terminal.

**NOTE:** *Make sure the ECM Ground strap is installed on the back of the ECM and not located between the ECM and Pulsar.*

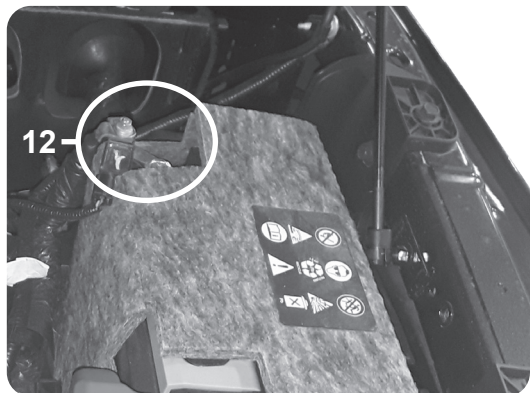



# 5.7L Controls

## Steering Wheel Controls

Pulsar power levels and Option menus are navigated using the right-side steering wheel buttons. Refer to the information below to better understand how these buttons are utilized.

2015-2018



Power Levels		
15-18	Function	19-22
RES+	Level Up	SET+
SET-	Level Down	SET-
CANCEL	View Level	CANC

2019-2022



Option Menu		
15-18	Function	19-22
Accel Pedal	Level Up/ Level Down	Accel Pedal
RES+	Select/Enter	SET+
CANCEL	Cancel	CANC

## Accelerator Pedal Controls

The accelerator pedal position is used to change the Tire Size and Axle Ratio values. When prompted to adjust the value displayed on the dash, push the pedal downward/upward to increase/decrease the value. Refer to the following example for more information.

Pedal Position

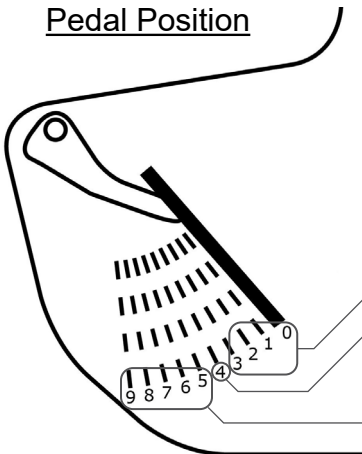

Dash Display

Units: Metric Example 1

Ratio: 4.10 Example 2

Units: English Example 3

# 5.7L Power Levels

## Levels Explained

There are 8 available level options:

- |                        |                                |
|------------------------|--------------------------------|
| Level 1 - STOCK        | Level 2 - STOCK MDS-OFF        |
| Level 3 - FUEL ECONOMY | Level 4 - FUEL ECONOMY MDS-OFF |
| Level 5 - TOW          | Level 6 - TOW MDS-OFF          |
| Level 7 - PERFORMANCE* | Level 8 - PERFORMANCE MDS-OFF* |

\*Minimum 91 octane fuel recommended.

## In-Dash Level Indicators

Power levels are indicated on the vehicle's in-dash display. Refer to the pics below to determine where the power level is viewed on your vehicle. *(The Pulsar device utilizes your radio's communication signals to interface with the gauge display.)*

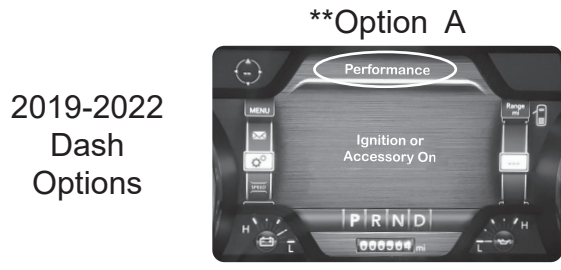
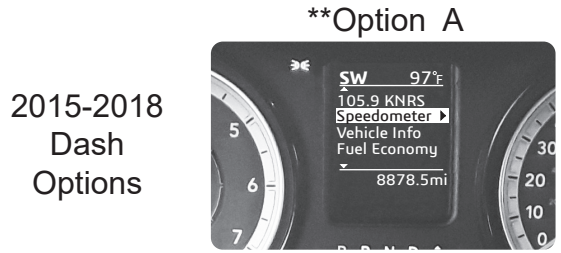

- \* Power levels will be viewable as soon as Pulsar is installed.
- \*\* In order to view power levels or modify tire size/axle ratios, vehicle display settings will need to be modified.

**NOTE:** When using MDS-OFF options, the dash display will show as if using manual gear shifting. This is to allow the Pulsar to control MDS, and **does not** actually put the vehicle into Manual Gear Shifting. On 2022 vehicles, you will get a message stating the ERS (Electronic Range Select) is Active. When using an 8 speed transmission, it will automatically switch to gear 8. And when using a 6 speed transmission, it will automatically switch to gear 6.

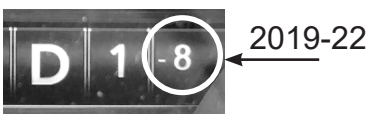
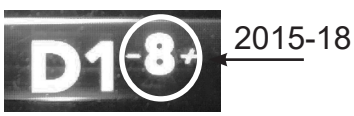

Manual Gear Shifting will work as normal when activated intentionally.

# Changing Power Levels (2015-2018)

## Dash Option A

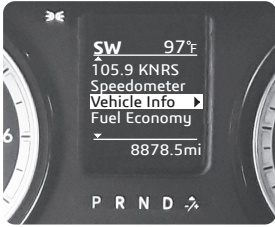

This dash display requires that menu settings be modified before Pulsar power levels can be adjusted and viewed.

**STEP 1** - Place the ignition into the RUN Position.

**STEP 2** - Using the left side buttons, enter the sub menu as shown below. Select the Audio option in the Info Line sub-menu. This will

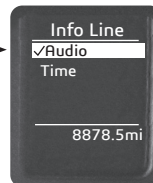
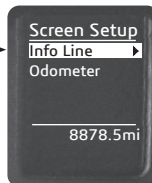
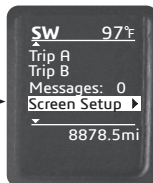

allow you to view the Pulsar Level while in the Main Menu.

**STEP 3** - Return to the main menu. The current radio station will be displayed. To view the current Pulsar power level, press the CANCEL button on the steering wheel. The level will be displayed.

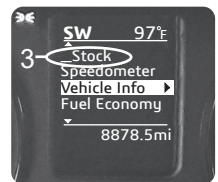

**STEP 4** - To modify the power levels, use the RES+ and SET- buttons. The new level will appear in the radio station slot.

## Dash Option B



**STEP 1** - Place the ignition into the RUN position.



**STEP 2** - Adjust the levels using the RES+ & SET- buttons. *The level indicator will show the current power level for 3 seconds.*

**STEP 3** - If you would like to temporarily view which level you are in, without changing levels, press CANCEL.

## Changing Power Levels (2019-2022)

For 2019-22 vehicles, the dash display settings will need to be modified prior to adjusting and viewing Pulsar power levels.

**STEP 1** - Place the ignition into the RUN  position.



**STEP 2** - Using the left side steering wheel controls, enter the Screen Setup menu.



**STEP 3** - Select the Center gauge as shown.

**STEP 4** - Scroll through the available options and select the Audio option. (The Pulsar device utilizes your radio's communication signals to interface with the gauge display.)

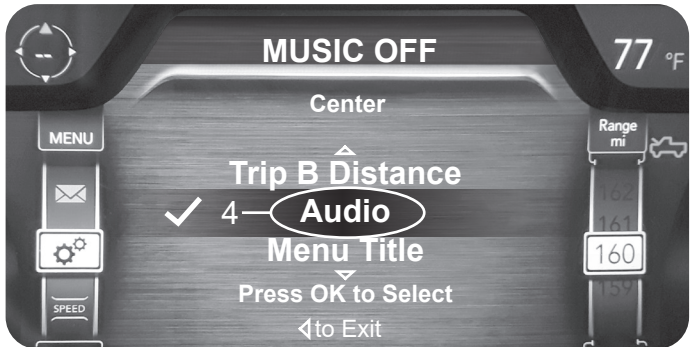

**STEP 5** - Now that the display settings are complete, press the CANC (Cancel) button located on the right side steering wheel controls.



**STEP 6** - To toggle through the levels, press SET+ or SET-.



# 5.7L Tire Size

## Tire Size Explained

The Pulsar allows you to adjust the vehicle's tire size settings. This feature corrects the speedometer based on tire size inputs.

## 2015-2018 Tire Size

Dash Option A

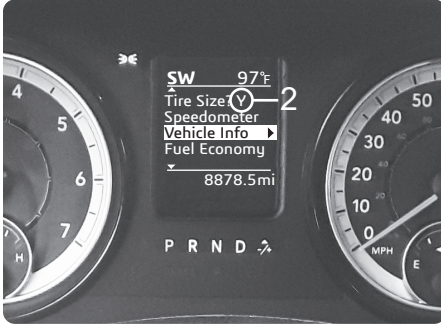

Dash Option B



**STEP 1** - With the ignition in the RUN position (Do Not Start), press and hold the CANC (Cancel) button for approximately 5 seconds. *The option to modify the Tire Size is displayed.*



**STEP 2** - Press down on the accelerator pedal to change the N (No) to Y (Yes).

**STEP 3** - While the Y (Yes) is displayed, press the RES+ button to select the option.

# 2015-2018 Tire Size Cont'd

**STEP 4** - Next, use the accelerator pedal to change the measure of units between English and Metric.

Dash Option A

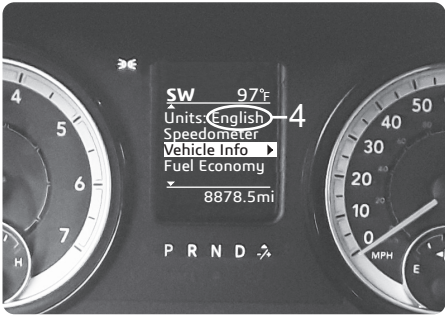

Dash Option B

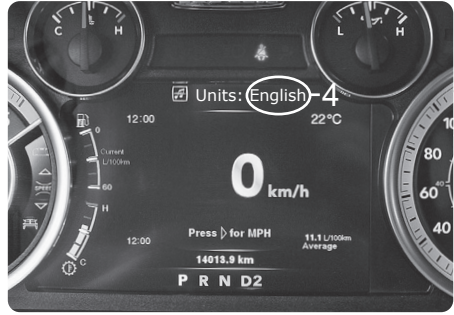

**STEP 5** - With the desired units displayed, press the RES+ button to select the Unit.

**STEP 6** - Use the accelerator pedal to adjust the number value, then press the RES+ button to select each value.

**NOTICE:** If using English units, the value for the tire size should be set to the total height of the tire, not the rim (from the floor to the top of the tire).

Dash Option A



Dash Option B



## 2019-2022 Tire Size

**STEP 1** - With the ignition in the RUN position (DO NOT start), press and hold the CANC (Cancel) button for approximately 5 seconds. *The option to modify the Tire Size is displayed on the center gauge. (NOTE: The SET- button allows you to return to the previous option.)*



**STEP 2** - Press down on the accelerator pedal to change the N (No) to Y (Yes).

**STEP 3** - While the Y (Yes) is displayed, press the SET+ button to select the option.

**STEP 4** - Next, use the accelerator pedal to change

the measure of units between English and Metric.



**NOTICE:** *If using English units, the value for the tire size should be set to the total height of the tire, not the rim (from the floor to the top of the tire).*

**STEP 5** - With the desired units displayed, press the SET+ button to select the Unit.



**STEP 6** - Use the accelerator pedal to adjust the number value, then press the SET+ button to select the displayed value.

# 5.7L Axle Ratio

## Axle Ratio Explained

In addition to Tire Size, Pulsar also allows you to correct the speedometer by adjusting the axle ratio settings. To make these adjustments, refer to the following set of instructions based on your vehicle year:

### 2015-2018 Axle Ratio

**STEP 1** - With the ignition in the RUN position (Do Not Start), press and hold the CANCEL (Cancel) button for approximately 5 seconds. *The option to modify the Tire Size is displayed. If modifying Tire Size, refer to the previous section. If not, select N (No) to skip to Axle Ratio.*

Dash Option A



Dash Option B



**STEP 2** - Press down on the accelerator pedal to change the N (No) to Y (Yes).

**STEP 3** - While the Y (Yes) is displayed, press the RES+ steering wheel button to select the option.



**STEP 4** - Use the accelerator pedal to adjust the number value, then press the RES+ button to select the displayed value.

Dash Option A



Dash Option B





## 2015-2018 Axle Ratio Cont'd

Once the desired Tire Size and/or Axle Ratio has been entered, you will be prompted to Program (Save the new settings). To save the settings, follow these instructions.

**STEP 5** - Press down on the accelerator pedal to change the N (No) to Y (Yes), then press the RES+ button to select the option.

Dash Option A



Dash Option B



**STEP 6** - Once the programming process has finished, you will be prompted to turn the key off.

Dash Option A



Dash Option B



Your vehicle settings are now updated and saved.

---

## 2019-2022 Axle Ratio

---

**STEP 1** - With the ignition in the RUN position (Do Not Start), press and hold the CANC (Cancel) button for approximately 5 seconds. *The option to modify the Tire Size is displayed. If modifying Tire Size, refer to the previous section. If not, select N (No) to skip to Axle Ratio.*

**STEP 2** - Press down on the accelerator pedal to change the N (No) to Y (Yes).

**STEP 3** - While the Y (Yes) is displayed, press the SET+ steering wheel button to select the option.



**STEP 4** - Use the accelerator pedal to adjust the number value, then press the SET+ button to select the displayed value.



*Once the desired Tire Size and/or Axle Ratio has been entered, you will be prompted to Program (Save the new settings). To save the settings, follow these instructions.*

**STEP 4** - Press down on the accelerator pedal to change the N (No) to Y (Yes), then press the SET+ button to select the option.



**STEP 5** - Once the programming process has finished, you will be prompted to turn the key off. Your vehicle settings are now updated and saved.

---

## Read DTC's

---

**STEP 1** - With the ignition in the RUN position (Do Not Start), press and hold the CANC (Cancel) button for approximately 5 seconds. *The option to modify the Tire Size is displayed. If modifying Tire Size, refer to the previous section. If not, select N (No) to skip to Axle Ratio. If modifying Axle Ratio refer to the previous section. If not, select N (No) to skip to Read DTCs.*

**STEP 2** - Press down on the accelerator pedal to change the N (No) to Y (Yes).

**STEP 3** - While the Y (Yes) is displayed, press the SET+ steering wheel button to select the option. If there are any DTCs present, they appear in a list that you can scroll using the SET+ and SET- buttons. At the end of the list, "End DTCs" is displayed. Pressing the SET+ button once more will exit the DTC list and move onto the Clear DTCs option.

---

## Clear DTC's

---

**STEP 1** - With the ignition in the RUN position (Do Not Start), press and hold the CANC (Cancel) button for approximately 5 seconds. *The option to modify the Tire Size is displayed. If modifying Tire Size, refer to the previous section. If not, select N (No) to skip to Axle Ratio. If modifying Axle Ratio refer to the previous section. If not, select N (No) to skip to Read DTCs. If reading DTCs, refer to the previous section. If not, select N (No) to skip to Clear DTCs.*

**STEP 2** - Press down on the accelerator pedal to change the N (No) to Y (Yes).

**STEP 3** - While the Y (Yes) is displayed, press the SET+ steering wheel button to select the option. Once DTCs have been cleared, "DTCs cleared" will be displayed briefly and the program will exit.

# 2015-18 Installation 6.4L Hemi

## Materials

---

Pulsar Module



Allen Wrench



4x - Washer

3x - Bolt

1x - Nut

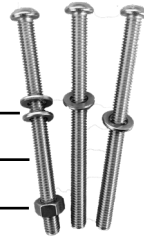

---

## Required Tools

---

Flat Head Screw Driver

1/2 Drive Ratchet

10mm Socket

10mm Wrench

Allen Wrench (provided)

*Note: It may be easier to use a 4mm Allen Socket instead of provided tool.*

---

## ECM Removal

---

**STEP 1** - Disconnect and remove the negative battery terminal.

**STEP 2** - Locate the vehicle's ECM. (1)

**2015-2018**

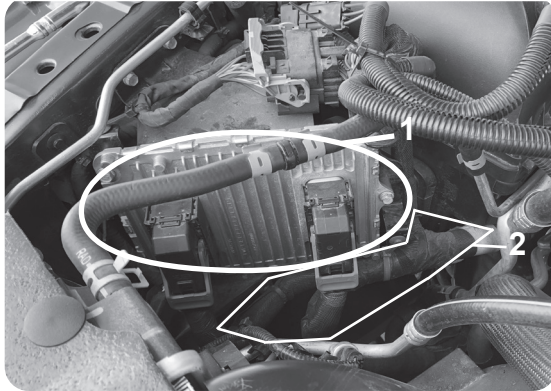

Cut the zip ties that fasten each connector harness to the metal bracket.

**STEP 3** - Use a flat head screw driver to press the lever lock towards the ECM. Gently lift up on the lever until you feel the lever release.

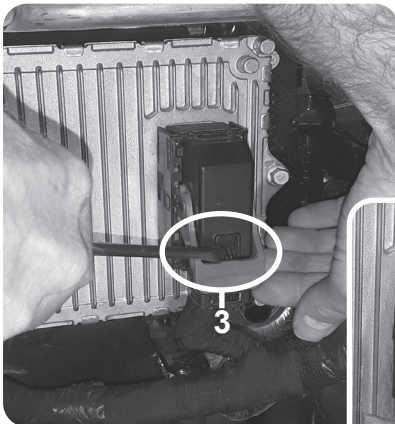

**STEP 4** - Once the lever is released, lift it upward until it stops. Disconnect the connector from the ECM.



**NOTE:** Follow steps 3 & 4 to remove both connectors.

---

## Pulsar Installation

---

**STEP 5** - Use a 10mm socket to loosen the 3 screws that fasten the ECM to the bracket.

*TIP: Hold the ECM with your other hand to prevent it from falling after the last screw is removed.*

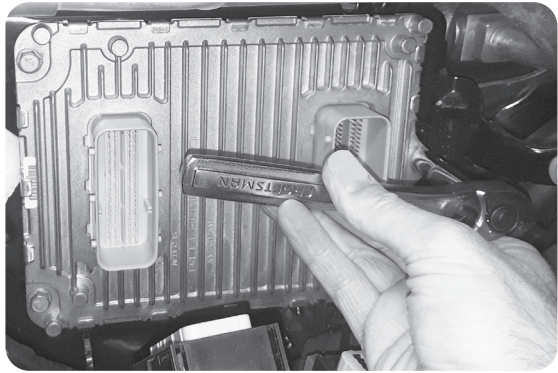

*TIP: Place the stock screws into a zip lock bag and store it in the glove box.*

**STEP 6** - Orient Pulsar and the ECM as shown. The three holes (A, B, & C) will be used to fasten the assembly to the bracket.

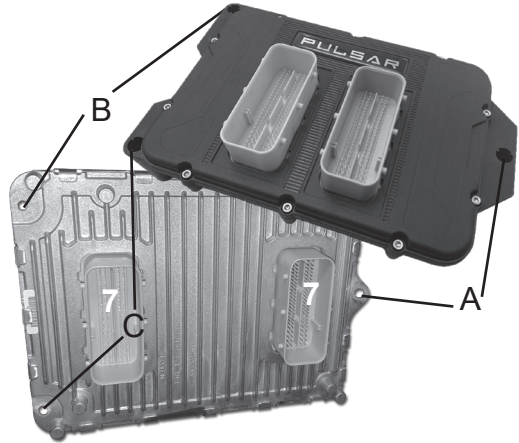

**STEP 7** - Align and insert the Pulsar's bottom side connectors with the ECM connectors.

**STEP 8** - While on a flat surface, apply enough pressure to fully seat the connectors. The top of the ECM connectors should sit flush with the Pulsar enclosure.

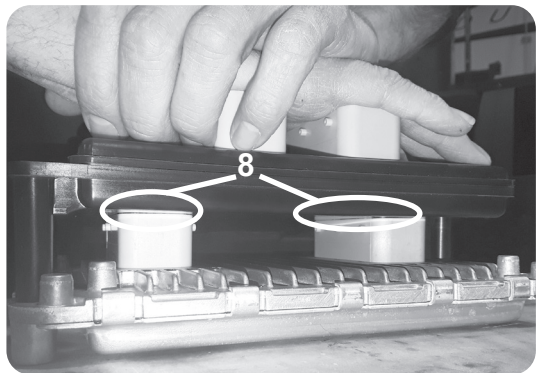

---

## Pulsar Installation Cont'd

---

**STEP 9** - Rotate Pulsar and PCM assembly, clockwise, over stock PCM mounting bracket (towards firewall) until assembly hole (c) lines up with upper stock bracket hole.

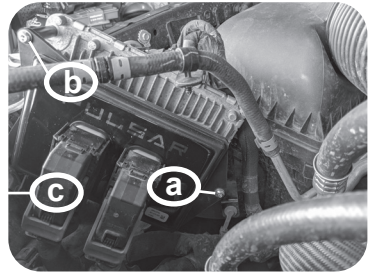

**Step 10** - Insert supplied bolts w/ washers into holes (a) and (c), tighten with the provided Allen Wrench until snug.

**Note:** The pulsar PCM assembly will now be permanently mounted on an angle from the original bracket.

**Step 11** - Insert final bolt w/ washer into hole (b) c and secure with supplied nut w/ washer. Tighten with the Allen Wrench and 10mm hand wrench until snug.

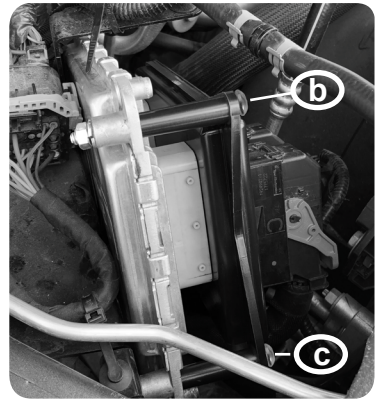

**STEP 12** - Gently insert the truck harness connectors into the Pulsar connectors. Push the lever down until it locks into place.

**STEP 13** - Reconnect the negative battery terminal.

**NOTE:** The lower hole on the mounting bracket should not be connected by a bolt to the assembly.

**NOTE:** Make sure the ECM Ground strap is installed on the back of the ECM and not located between the ECM and Pulsar.

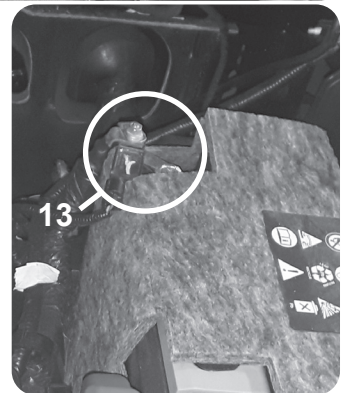

# 2019-22 Installation 6.4L Hemi

## Materials

---

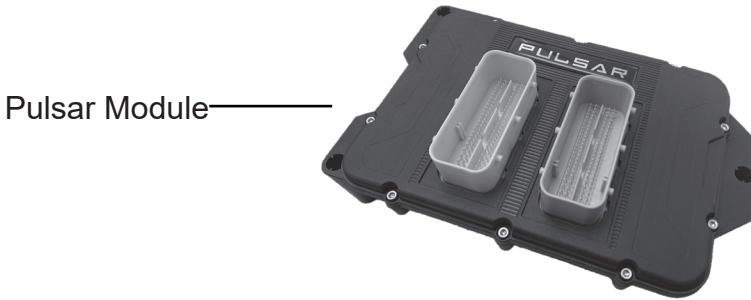

3x - Washer



3x - Shoulder Bolt



---

## Required Tools

---

Flat Head Screw Driver

1/2 Drive Ratchet

10mm Socket

10mm Wrench



---

## ECM Removal

---

**STEP 1** - Disconnect and remove the negative battery terminal.

**STEP 2** - Locate the vehicle's ECM. (1)  
**2019-2022**

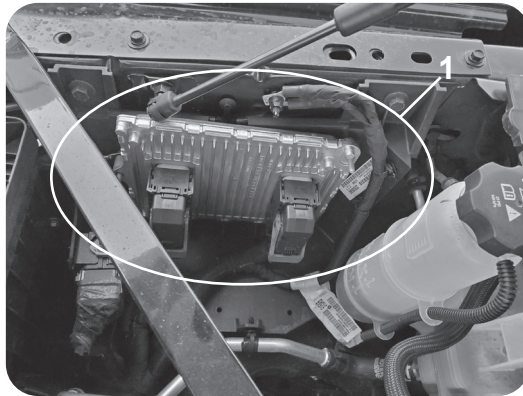

Cut the zip ties that fasten each connector harness to the metal bracket.

**STEP 3** - Use a flat head screw driver to press the lever lock towards the ECM. Gently lift up on the lever until you feel the lever release.

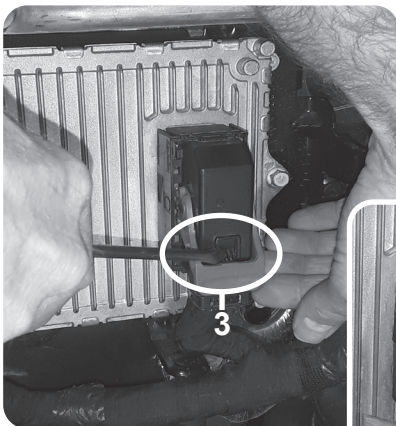

**STEP 4** - Once the lever is released, lift it upward until it stops. Disconnect the connector from the ECM.



**NOTE:** Follow steps 3 & 4 to remove both connectors.

---

## Pulsar Installation

---

**STEP 5** - Use a 10mm socket to loosen the 3 nuts that fasten the ECM to the bracket.

*TIP: Hold the ECM with your other hand to prevent it from falling after the last screw is removed.*

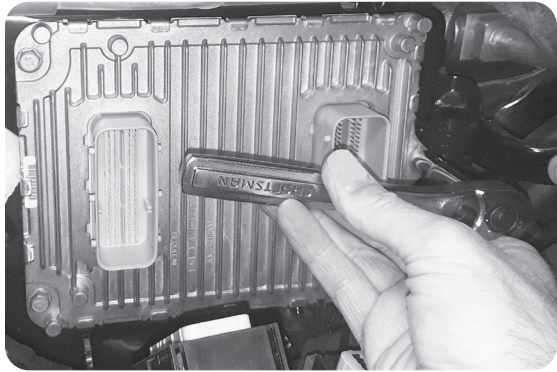

*TIP: Place the stock screws into a zip lock bag and store it in the glove box.*

**STEP 6** - Orient Pulsar and the ECM shown. The three holes (A, B, & C) will be used the bracket.

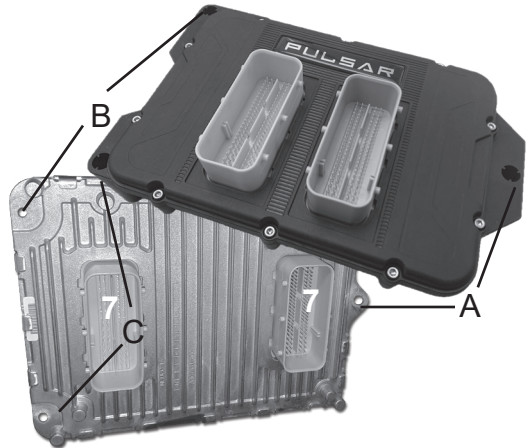

**STEP 7** - Align and insert the Pulsar's bottom side connectors with the ECM connectors.

**STEP 8** - While on a flat surface, apply enough pressure to fully seat the connectors. The top of the ECM connectors should sit flush with the Pulsar enclosure.

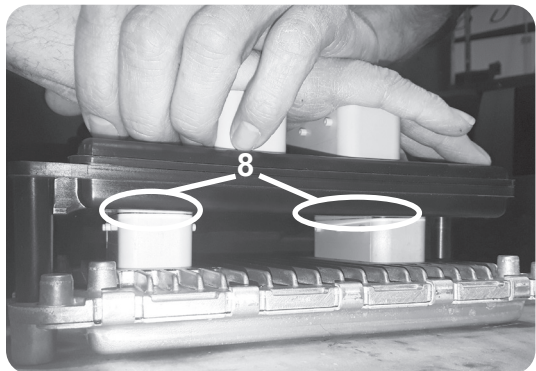

---

## Pulsar Installation Cont'd

---

**STEP 9** - Gently insert the truck harness connectors into the Pulsar connectors. Push the lever down until it locks into place.

**STEP 10** - Insert the supplied shoulder bolts w/ washers into holes and tighten with a 10mm hand wrench until snug.

**STEP 11** - Reconnect the negative battery terminal.

**NOTE:** Make sure the ECM Ground strap is installed on the back of the ECM and not located between the ECM and Pulsar.

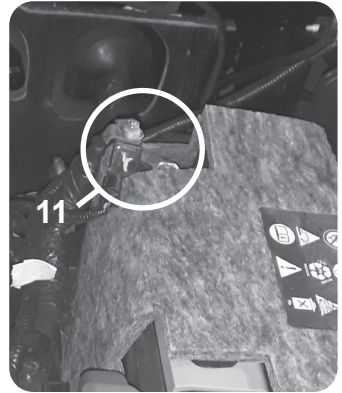
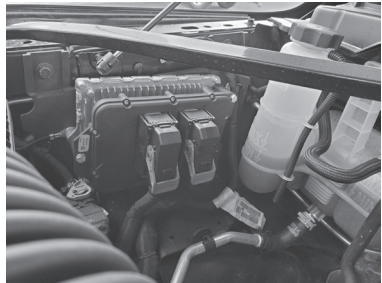

# 6.4L Controls

## Steering Wheel Controls

Pulsar power levels and Option menus are navigated using the right-side steering wheel buttons. Refer to the information below to better understand how these buttons are utilized.

2015-2022



Power Levels	
15-22	Function
RES+	Level Up
SET-	Level Down
CANCEL	View Level

Option Menus		
15-18	Function	19-22
Accel Pedal	Level Up/ Level Down	Accel Pedal
RES+	Select/Enter	SET+
CANCEL	Cancel	CANC

## Accelerator Pedal Controls

The accelerator pedal position is used to change the Tire Size and Axle Ratio values. When prompted to adjust the value displayed on the dash, push the pedal downward/upward to increase/decrease the value. Refer to the following example for more information.

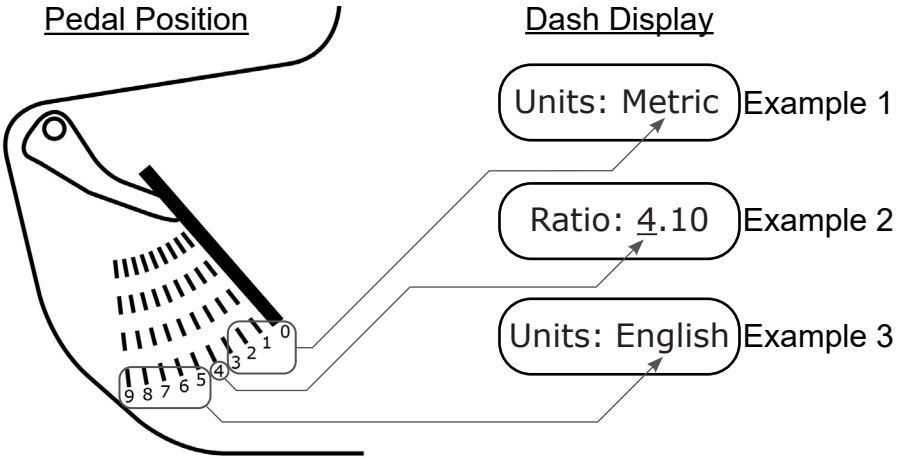

# 6.4L Power Levels

## Levels Explained

There are 8 available level options:

- |                        |                                |
|------------------------|--------------------------------|
| Level 1 - STOCK        | Level 2 - STOCK MDS-OFF        |
| Level 3 - FUEL ECONOMY | Level 4 - FUEL ECONOMY MDS-OFF |
| Level 5 - TOW          | Level 6 - TOW MDS-OFF          |
| Level 7 - PERFORMANCE* | Level 8 - PERFORMANCE MDS-OFF* |

\*Minimum 91 octane fuel recommended.

## In-Dash Level Indicators

Power levels are indicated on the vehicle's in-dash display. Refer to the pics below to determine where the power level is viewed on your vehicle. *(The Pulsar device utilizes your radio's communication signals to interface with the gauge display.)*

\*\*Option A

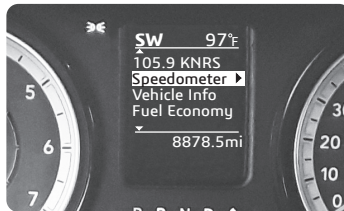

2015-2022  
Dash  
Options

- \* Power levels will be viewable as soon as Pulsar is installed.
- \*\* In order to view power levels or modify tire size/axle ratios, vehicle display settings will need to be modified.

\*Option B



**NOTE:** When using MDS-OFF options, the dash display will show as if using manual gear shifting. This is to allow the Pulsar to control MDS, and **does not** actually put the vehicle into Manual Gear Shifting.

When using an 8 speed transmission, it will automatically switch to gear 8. And when using a 6 speed transmission, it will automatically switch to gear 6.



2015-22

Manual Gear Shifting will work as normal when activated intentionally.

## Changing Power Levels (2015-2022)

### Dash Option A

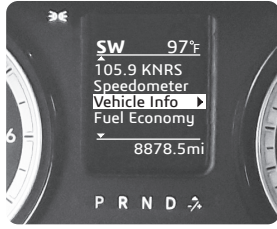

This dash display requires that menu settings be modified before Pulsar power levels can be adjusted and viewed.

**STEP 1** - Place the ignition into the RUN Position.

**STEP 2** - Using the left side buttons, enter the sub menu as shown below. Select the Audio option in the Info Line sub-menu. This will

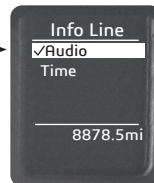
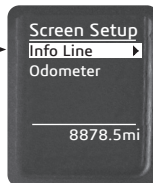
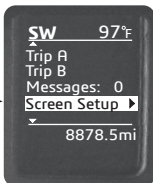

allow you to view the Pulsar Level while in the Main Menu.

**STEP 3** - Return to the main menu. The current radio station will be displayed. To view the current Pulsar power level, press the CANCEL button on the steering wheel. The level will be displayed.



**STEP 4** - To modify the power levels, use the RES+ and SET- buttons. The new level will appear in the radio station slot.

### Dash Option B



**STEP 1** - Place the ignition into the RUN position.



**STEP 2** - Adjust the levels using the RES+ & SET- buttons. *The level indicator will show the current power level for 3 seconds.*

**STEP 3** - If you would like to temporarily view which level you are in, without changing levels, press CANCEL.

# 6.4L Tire Size

## Tire Size Explained

The Pulsar allows you to adjust the vehicle's tire size settings. This feature corrects the speedometer based on tire size inputs.

## 2015-2022 Tire Size

Dash Option A

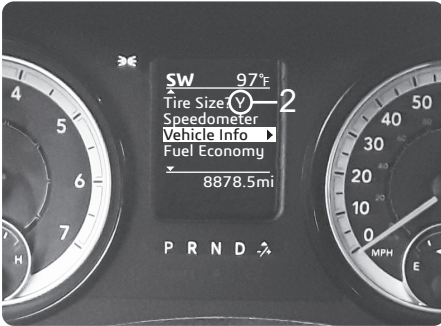

Dash Option B



**STEP 1** - With the ignition in the RUN position (Do Not Start), press and hold the CANCEL (Cancel) button for approximately 5 seconds. *The option to modify the Tire Size is displayed.*



**STEP 2** - Press down on the accelerator pedal to change the N (No) to Y (Yes).

**STEP 3** - While the Y (Yes) is displayed, press the RES+ button to select the option.

## 2015-2022 Tire Size Cont'd

**STEP 4** - Next, use the accelerator pedal to change the measure of units between English and Metric.

Dash Option A

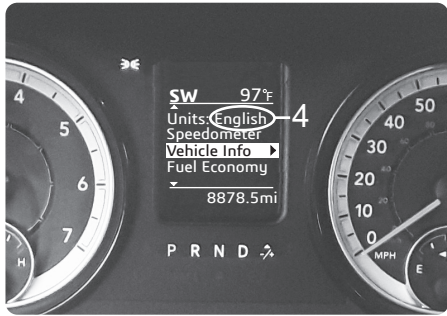

Dash Option B

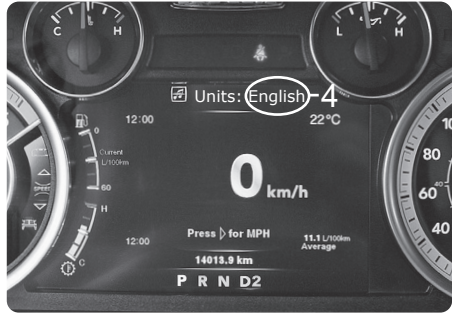

**STEP 5** - With the desired units displayed, press the RES+ button to select the Unit.

**STEP 6** - Use the accelerator pedal to adjust the number value, then press the RES+ button to select each value.

**NOTICE:** If using English units, the value for the tire size should be set to the total height of the tire, not the rim (from the floor to the top of the tire).

Dash Option A



Dash Option B

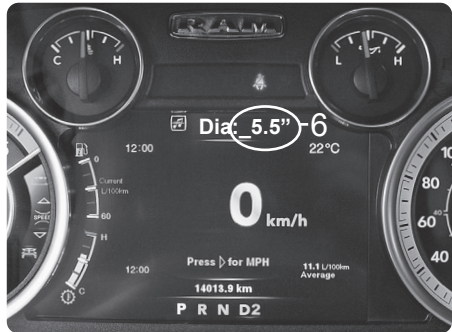



# 6.4L Axle Ratio

## Axle Ratio Explained

In addition to Tire Size, Pulsar also allows you to correct the speedometer by adjusting the axle ratio settings. To make these adjustments, refer to the following set of instructions based on your vehicle year:

### 2015-2022 Axle Ratio

**STEP 1** - With the ignition in the RUN position (Do Not Start), press and hold the CANC (Cancel) button for approximately 5 seconds. *The option to modify the Tire Size is displayed. If modifying Tire Size, refer to the previous section. If not, select N (No) to skip to Axle Ratio.*

Dash Option A



Dash Option B



**STEP 2** - Press down on the accelerator pedal to change the N (No) to Y (Yes).

**STEP 3** - While the Y (Yes) is displayed, press the RES+ steering wheel button to select the option.



**STEP 4** - Use the accelerator pedal to adjust the number value, then press the RES+ button to select the displayed value.

Dash Option A

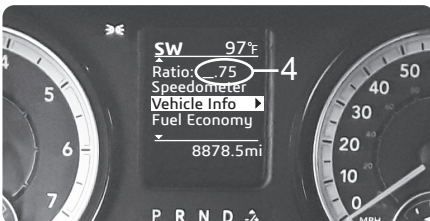

Dash Option B



# 2015-2022 Axle Ratio Cont'd

Once the desired Tire Size and/or Axle Ratio has been entered, you will be prompted to Program (Save the new settings). To save the settings, follow these instructions.

**STEP 5** - Press down on the accelerator pedal to change the N (No) to Y (Yes), then press the RES+ button to select the option.

Dash Option A



Dash Option B



**STEP 6** - Once the programming process has finished, you will be prompted to turn the key off.

Dash Option A

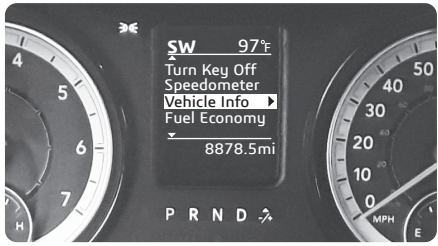

Dash Option B

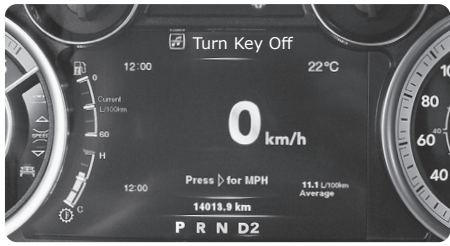

Your vehicle settings are now updated and saved.

---

## Read DTC's

---

**STEP 1** - With the ignition in the RUN position (Do Not Start), press and hold the CANC (Cancel) button for approximately 5 seconds. *The option to modify the Tire Size is displayed. If modifying Tire Size, refer to the previous section. If not, select N (No) to skip to Axle Ratio. If modifying Axle Ratiom refer to the previous section. If not, select N (No) to skip to Read DTCs.*

**STEP 2** - Press down on the accelerator pedal to change the N (No) to Y (Yes).

**STEP 3** - While the Y (Yes) is displayed, press the SET+ steering wheel button to select the option. If there are any DTCs present, they appear in a list that you can scroll using the SET+ and SET- buttons. At the end of the list, "End DTCs" is displayed. Pressing the SET+ button once more will exit the DTC list and move onto the Clear DTCs option.

---

## Clear DTC's

---

**STEP 1** - With the ignition in the RUN position (Do Not Start), press and hold the CANC (Cancel) button for approximately 5 seconds. *The option to modify the Tire Size is displayed. If modifying Tire Size, refer to the previous section. If not, select N (No) to skip to Axle Ratio. If modifying Axle Ratiom refer to the previous section. If not, select N (No) to skip to Read DTCs. If reading DTCs, refer to the previous section. If not, select N (No) to skip to Clear DTCs.*

**STEP 2** - Press down on the accelerator pedal to change the N (No) to Y (Yes).

**STEP 3** - While the Y (Yes) is displayed, press the SET+ steering wheel buton to select the option. Once DTCs have been cleared, "DTCs cleared" will be displayed briefly and the program will exit.

# Update Software

## Downloading Update Agent 1.0 (Optional)

The Update Agent may be used to update the device via the USB connection. The software can be downloaded through the internet. This process currently can only be done on a Windows computer, **Mac devices are not supported**.

**NOTE:** It is recommended to install Update Agent 1.0 on a laptop computer for best accessibility (you will need to connect the computer to the vehicle's OBDII port to perform updates).

**STEP 1** - Go to a computer with internet access, and go to one of the following websites: **superchips.com - diabloSPORT.com - edgeproducts.com**

**STEP 2** - Go to the website's Updates/Downloads tab and click the link "Download Update Agent 1.0" and save the .exe file to a findable location on the computer.

**STEP 3** - Run the .exe installation program that you downloaded, and read through the license terms and conditions, check the agreement box and click Install. Continue through installation until it says Installation Successfully Completed. Click Close to finish the process.

**NOTE:** If given a Security Warning pop-up upon install, click run to proceed. Also, if asked, install **Holley USBCAN Driver** as well as Update Agent 1.0. This driver is required to connect to the device.

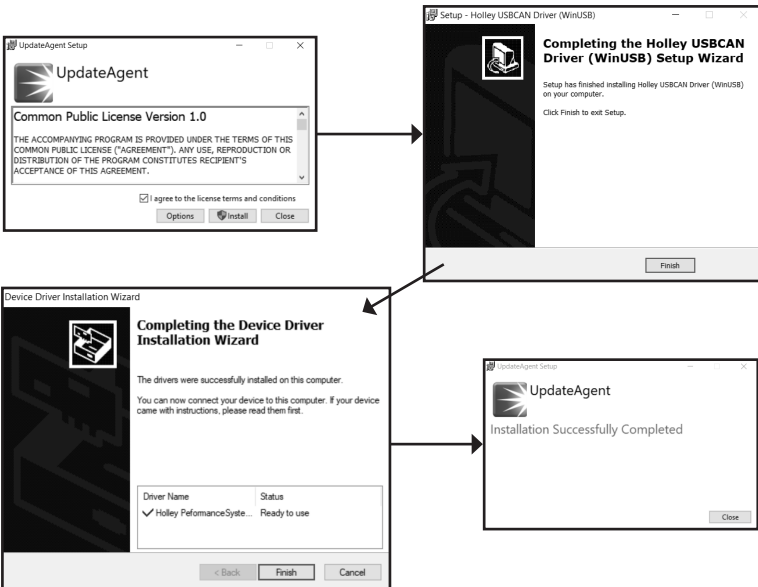

# Product Updates

This device has the ability to update via a USB connection. A USB to OBDII update cable is required to perform the update. **It is recommended that a battery charger is attached and turned on during the update process.**

**NOTE:** The Pulsar must be installed into a vehicle before updating. When updating, you CANNOT use your vehicle's Wi-Fi. It will be disabled during the update process. Use an external source such as your home Wi-Fi.

**STEP 1** - Take computer with Update Agent 1.0 installed to the location of the vehicle with the Pulsar device.

**STEP 2** - Turn the vehicle's ignition to the RUN position (do not start the engine) and then open Update Agent 1.0 on the computer, and plug in USB to OBDII cable into both the vehicle's OBDII port and a USB port on the computer.

**STEP 3** - Update Agent 1.0 should automatically detect the Pulsar device; follow onscreen instructions until it checks for an update. If an update is available, click yes.

**NOTE:** If you have not yet registered for an account and/or signed in, you will be prompted to do so before you can proceed with the update.

**STEP 4** - Follow update steps as shown onscreen. Do not power down the vehicle during the entire process unless prompted by the Update Agent. Once Update Agent 1.0 says "Your device is up-to-date," click ok and disconnect the USB to OBDII cable.

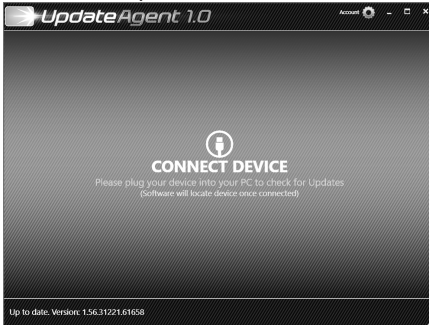

**NOTICE:** Update Cable not included, must be purchased separately

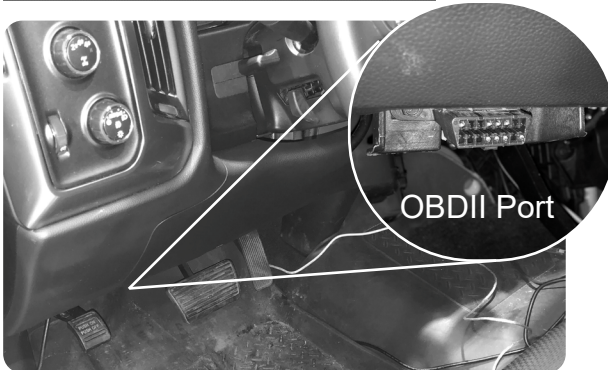

**NOTE:**  
OBDII Port location may vary depending on vehicle

# FAQs

---

## Frequently Asked Questions

---

**Question:** Why does the power level flicker? Is this normal?

**Answer:** Yes. This is due to the way Pulsar has to “piggy back” onto the existing communication lines.

**Question:** Can I adjust power levels when cruise control is on?

**Answer:** No, only when cruise control is off.

**NOTE:** *Cruise control can be used as normal, you just can't change power levels when cruise control is on.*

**Question:** Why is the ECO Light still on when I am in a power level where MDS is disabled?

**Answer:** The ECO light illuminates when the vehicle is being driven economically. The light is not tied directly to MDS functionality. It will still illuminate when Pulsar disables MDS.

**Question:** Should I remove the Pulsar prior to going to the dealer?

**Answer:** Yes, please remove the Pulsar as to eliminate it from the system so they can perform any updates or services.

**Question:** How do I check what level I am on when cruise control is off?

**Answer:** Simply press CANC on power steering keypad.

**Question:** Can I “stack” or use other tuners with this device?

**Answer:** No, please do not use any other tuners when the Pulsar is in use or installed. Stacking tuners with the Pulsar may cause serious damage to the vehicle.

---

---

PAGE INTENTIONALLY LEFT BLANK

*For additional questions not found in the user guide, call:*

**Holley Technical Support: (888)-360-3343**

Mon - Fri 8:00 am - 5:00 pm MST, Sat 8:00 am - 2:00 pm MST

**To expedite your support call, please have your Vehicle Information,  
Part Number, and Serial Number ready prior to calling Technical Support.**

**Holley**<sup>®</sup>  
TUNING GROUP

© Copyright 2023 Holley Inc. and subsidiaries. All rights reserved.

D10022800 Rev09 05/02/2023